

assembly plan (type: B102)

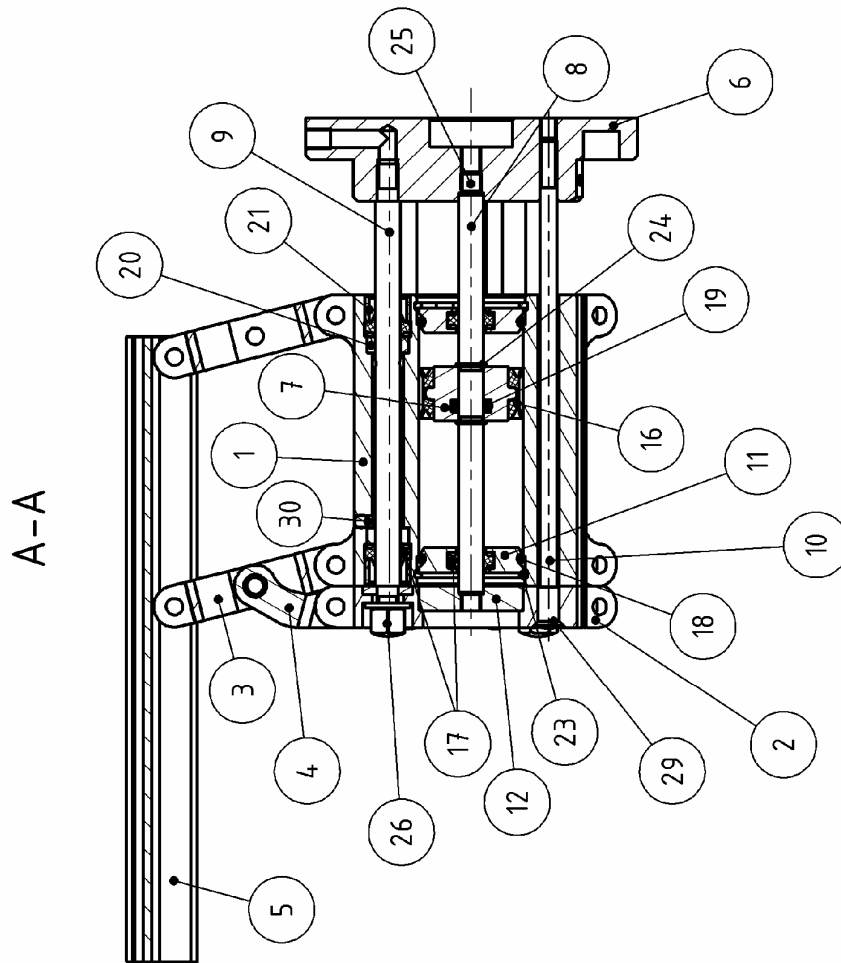
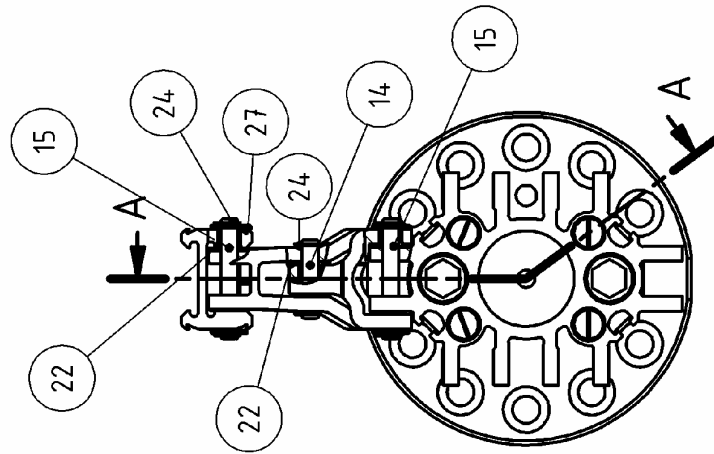

**address:**

GMG – Gesellschaft für modulare  
Greifersysteme mbH  
Rodinger Weg 8H • D-59494 Soest  
Germany

**phone:**

+49 (0)2921 - 4062

**fax:**

+49 (0)2921 - 4042

**e-mail:**

info@gmg-system.com

**homepage:**

http://www.gmg-system.com

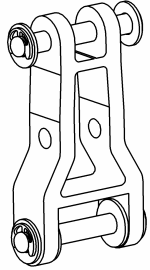
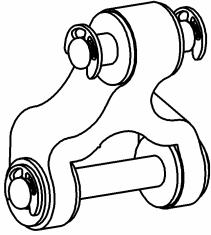
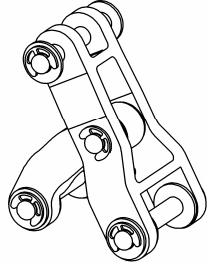
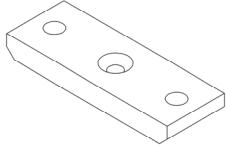
Pos. 4 + 5		Link, Crank, Crank Mechanism, Counter Plate		
Article	Component	Ident.	Scope of Delivery	
Link	02	LE04	Link (3), Slide Bearing (22), Bearing Pins (15), Washer and Circlips.	
Crank	03	KU04	Crank (4), Slide Bearings (22) Bearing Pins (14 + 15), Washer and Circlips	
Crank Mechanism	51	KT04	Link (3), Crank (4), Slide Bearings (22) Bearing Pins (14 + 15), Washer and Circlips	
Counter Plate	07	GP03	Counter Plate for shoe attachment. Only for fingers with finger length F=0 and standard bore template.	

### Order Number:

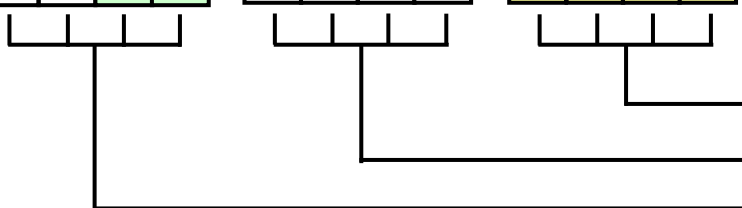
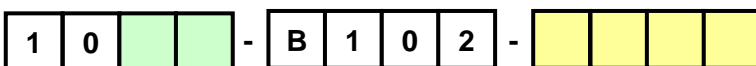

Ident.

Type of Gripper

Component

**address:**

GMG – Gesellschaft für modulare Greifersysteme mbH  
 Rodinger Weg 8H • D-59494 Soest  
 Germany

**phone:**

+49 (0)2921 - 4062

**fax:**

+49 (0)2921 - 4042

**e-mail:**

info@gmg-system.com

**homepage:**

http://www.gmg-system.com

Pos. 6			Finger			
Finger Length			Finger Movement			
Length Dimension (L) [mm]	Length Dimension (F) [mm]	Ident.	Finger Movement	Bore Dimension		Ident.
				(H) [mm]	(G) [mm]	
70	0	000	parallel open parallel close	60	5	A
90	20	020				
110	40	040	parallel open swiveling close	80		C
130	60	060				
150	80	080	swiveling open swiveling close	100		
Special Length		(F) in mm			Finger Type	
			Without Bore		00	
			With Bore		01	

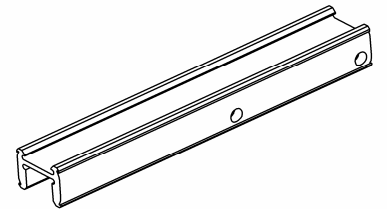

### Order Number:

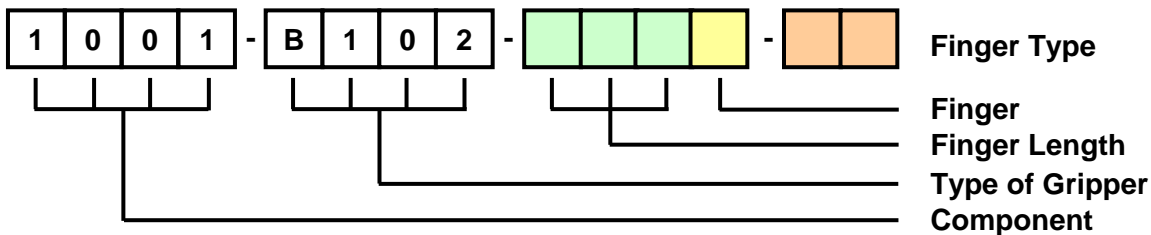

Scope of Delivery
Finger (5), Slide Bearings (22)

Pos. 14, 15, 16		Bearing Pins	
Article	Component	Ident.	Scope of Delivery
Bearing Pin	01	B041	Bearing Pin (14), Washer and Circlip (22)
Bearing Pin	02	B042	Bearing Pin (15), Washer and Circlip (22)
Bearing Pin	03	B043	Bearing Pin for Double Finger, Washer and Circlip (22)

### Order Number:

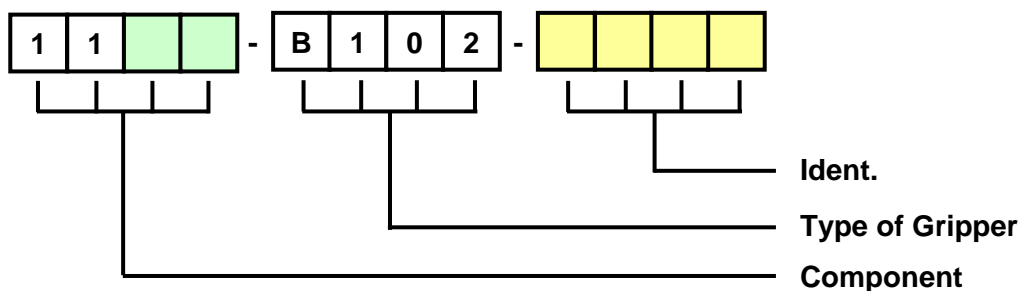

#### address:

GMG – Gesellschaft für modulare Greifersysteme mbH  
Rodinger Weg 8H • D-59494 Soest  
Germany

#### phone:

+49 (0)2921 - 4062

#### fax:

+49 (0)2921 - 4042

#### e-mail:

info@gmg-system.com

#### homepage:

http://www.gmg-system.com

## Pos. 4, 5, 6 Finger Mechanism

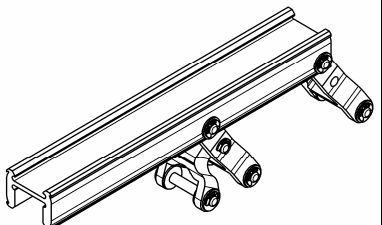
Finger Length			Finger Movement			
Length Dimension		Ident.	Finger Movement	Bore Dimension		Ident.
(L) [mm]	(F) [mm]			(H) [mm]	(G) [mm]	
70	0	000	parallel open parallel close	60	5	A
90	20	020				
110	40	040	parallel open swiveling close	80		B
130	60	060				
150	80	080	swiveling open swiveling close	100		C
Special Length		(F) in mm				
Finger Type						
Without Bore						
With Bore						01

### Order Number:

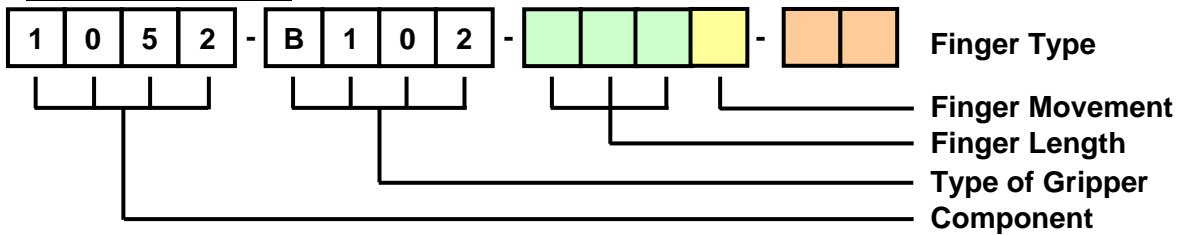

Scope of Delivery
Finger (5), Link (3), Crank (4), Slide Bearing(22), Bearing Pin (14 + 15), Washer and Circlip

## Operating Unit

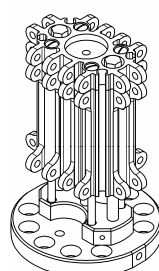
Pos.	Article	Order Number: 1079-B102-BE04
1-2, 6-13, 16-21, 23-26, 28-30	Operating Unit	

## Spare Part Kit 1 (Piston Unit)

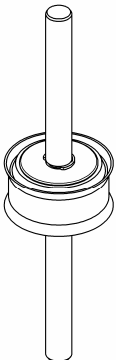
Pos.	Article	Quantity	Order Number: 1080-B102-KE04
7	Piston	1	
8	Piston Rod	1	
16	Piston Sealing	1	
19	O-Ring	1	
24	Circlip	2	

## Spare Part Kit 2 (Cylinder Cover)

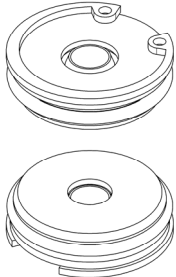
Pos.	Article	Quantity	Order Number: 1081-B102-ZD04
11	Cylinder Cap	2	
27	Seal and Stripper	2	
18	O-Ring	2	
23	Circlip	2	

## Spare Part Kit 3 (Sliding Rods)

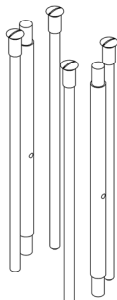
Pos.	Article	Quantity	Order Number: 1082-B102-FS04
9	Sliding rod wit bore	2	
10	Tie	4	
26	Cap Nut	2	
29	Sleeve Nut	8	
28	Spring Washer	2	

**address:**

GMG – Gesellschaft für modulare Greifersysteme mbH  
 Rodinger Weg 8H • D-59494 Soest  
 Germany

**phone:**

+49 (0)2921 - 4062

**fax:**

+49 (0)2921 - 4042

**e-mail:**

info@gmg-system.com

**homepage:**

http://www.gmg-system.com

## Seal Kit 02

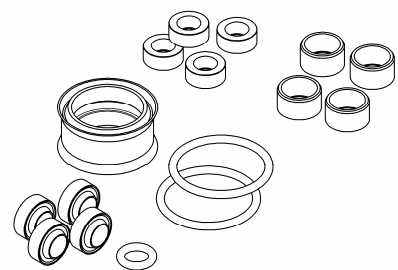
Pos.	Article	Quantity	Order Number: 1090-B102-DS02
16	Piston Seal	1	
17	Seal and Stripper	6	
18	O-Ring	2	
19	O-Ring	1	
20	Slide Bearing	4	
21	Seal Holding Ring	4	

## Proximity Switch

Scope of Delivery	Order Number
<i>Proximity Switch (PNP) with Extension</i>	<b>1049-B102-PN01</b>
<i>Proximity Switch (PNP) without Extension</i>	<b>1049-B102-PN00</b>

## Proximity Switch Kit

Scope of Delivery	Order Number
<i>1 Proximity Switch (PNP) with Extension, Magnetic Carrier, Fixation Bar for 2 proximity switches minimum, fixing screws</i>	<b>1050-B102-PN01</b>
<i>1 Proximity Switch (PNP) without Extension, Magnetic Carrier, Fixation Bar for 2 proximity switches minimum, fixing screws</i>	<b>1050-B102-PN00</b>

## Mounting Elements for Proximity Switch

Scope of Delivery	Order Number
<i>Magnetic Carrier, Fixation Bar for 2 proximity switches minimum, fixing screws</i>	<b>1005-B102-BESG</b>

We only deliver to the INCOTERMS latest edition.  
 All printing and clerical errors are subject to correction without liability!  
 Prices and delivery times can only be provided through an individual quote.