

Assembly Drawing (Type: W103)

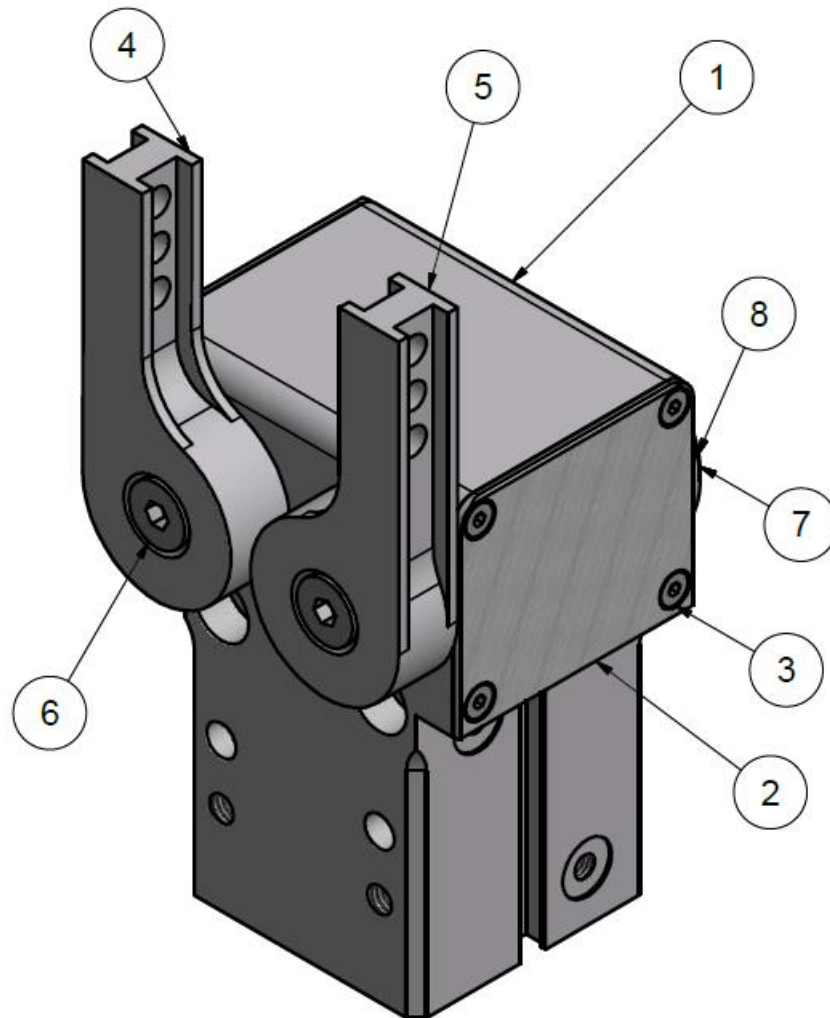

Address:

GMG – Gesellschaft fuer modulare
Greifersysteme mbH
Rodinger Weg 8H • 59494 Soest
Germany

Phone:

+49 (0)2921 - 4062

Fax:

+49 (0)2921 - 4042

E-mail:

info@gmg-system.com

Homepage:

<http://www.gmg-system.com>

Spare Part List for Gripper **W103**

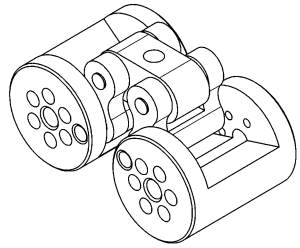
Gear Unit			
Pos.	Article	Quantity	Order Number: 1201-WG03-GE03
	Gear Unit	1	

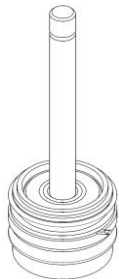
Piston Unit			
Pos.	Article	Quantity	Order Number: 1202-WG03-KE03
	Piston Unit	1	

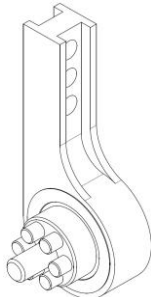
Finger Right (single)			
Pos.	Article	Quantity	Order Number: 1203-WG03-FR03
5	Finger Right	1	
6	Fixing Screw	1	
	Pin	6	

Address:

GMG – Gesellschaft fuer modulare Greifersysteme mbH
 Rodinger Weg 8H • 59494 Soest
 Germany

Phone:

+49 (0)2921 - 4062

Fax:

+49 (0)2921 - 4042

E-mail:

info@gmg-system.com

Homepage:

http://www.gmg-system.com

Spare Part List for Gripper **W103**

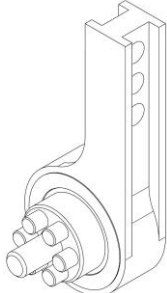
Finger Left (single)			
<i>Pos.</i>	<i>Article</i>	<i>Quantity</i>	Order Number: 1203-WG03-FL03
4	Finger Left	1	
6	Fixing Screw	1	
	Pin	6	

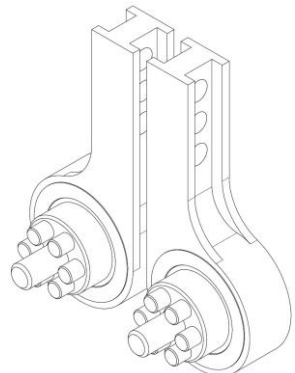
Finger Pair			
<i>Pos.</i>	<i>Article</i>	<i>Quantity</i>	Order Number: 1203-WG03-FP03
4	Finger Left	1	
5	Finger Right	1	
6	Fixing Screw	2	
	Pin	16	

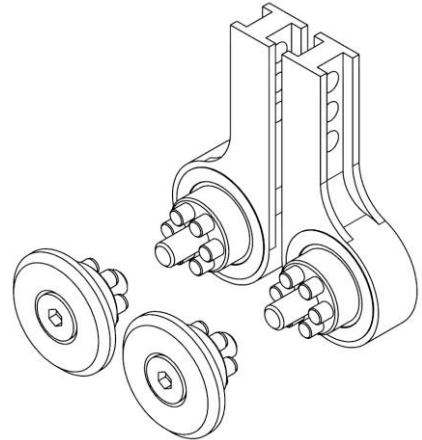
Finger Set			
<i>Pos.</i>	<i>Article</i>	<i>Quantity</i>	Order Number: 1203-WG03-FS03
	Counter Bearing	2	
4	Finger Left	1	
5	Finger Right	1	
6	Fixing Screw	2	
	Fixing Screw	2	
	Pin	24	
	Finger Seal	4	

Address:

GMG – Gesellschaft fuer modulare Greifersysteme mbH
 Rodinger Weg 8H • 59494 Soest
 Germany

Phone:

+49 (0)2921 - 4062

Fax:

+49 (0)2921 - 4042

E-mail:

info@gmg-system.com

Homepage:

http://www.gmg-system.com

Spare Part List for Gripper **W103**

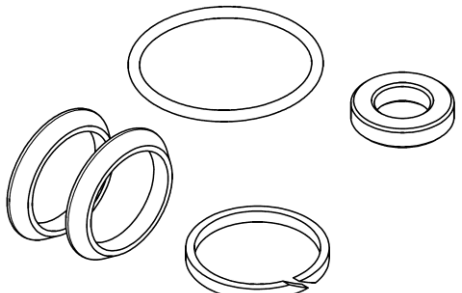
Seal Kit (small)			
Pos.	Article	Quantity	Order Number: 1204-WG03-DS03
	Damping Ring	1	
	Guide Band	1	
	O-ring	1	
	Piston Seal	2	

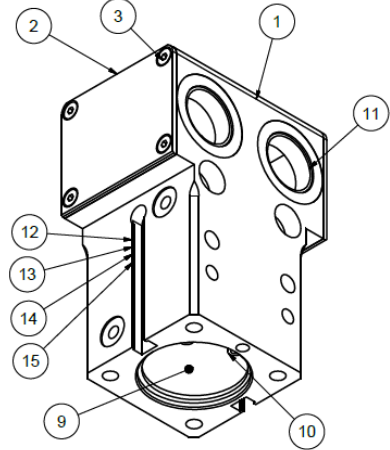
Body			
Pos.	Article:	Quantity:	Order Number: 1205-WG03-GH03
1	Body	1	
2	Side Cover	2	
3	Fixing Screw	8	
10	Circlip	1	
9	Cylinder Cover	1	
11	Neck Bearing	4	
12	Slide Bearing	1	
13	Rod Seal	1	
14	O-ring	1	
15	Supporting Ring	1	

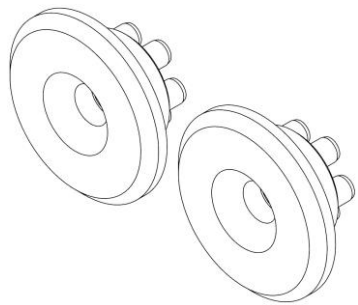
Counter Bearing			
Pos.	Article	Quantity	Order Number: 1206-WG03-WL03
7	Counter Bearing	2	
	Pin	12	

Address:

GMG – Gesellschaft fuer modulare Greifersysteme mbH
 Rodinger Weg 8H • 59494 Soest
 Germany

Phone:

+49 (0)2921 - 4062

Fax:

+49 (0)2921 - 4042

E-mail:

info@gmg-system.com

Homepage:

http://www.gmg-system.com

Spare Part List for Gripper **W103**

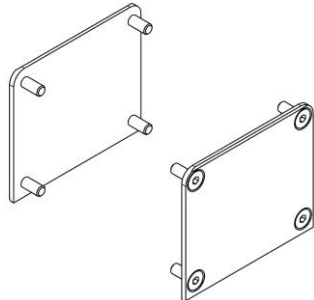
Side Cover			
Pos.	Article	Quantity	Order Number: 1207-WG03-AB03
2	Side Cover	2	
3	Fixing Screw	8	

Reduction Sleeve			
Pos.	Article	Quantity	Order Number: 1208-WG03-RH03
	Reduction Sleeve	1	
	O-ring	2	

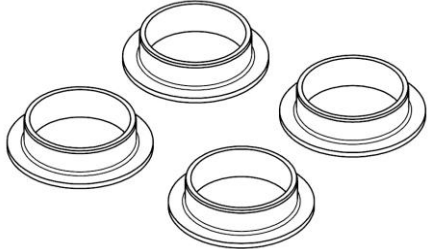
Neck Bearing			
Pos.	Article	Quantity	Order Number: 1210-WG03-HL03
11	Neck Bearing	4	

Blind Plug			
Pos.	Article	Quantity	Order Number: 1211-WG03-BS00
	Blind Plug	2	

Address:

GMG – Gesellschaft fuer modulare Greifersysteme mbH
 Rodinger Weg 8H • 59494 Soest
 Germany

Phone:

+49 (0)2921 - 4062

Fax:

+49 (0)2921 - 4042

E-mail:

info@gmg-system.com

Homepage:

http://www.gmg-system.com

Spare Part List for Gripper **W103**

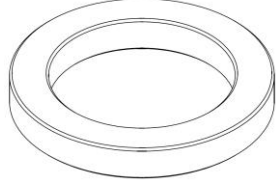
Ring Magnet			
Pos.	Article	Quantity	Order Number: 1213-WG03-MR03
	Ring Magnet	1	

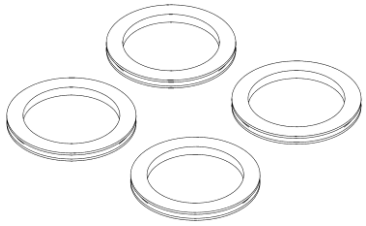
Finger Seal			
Pos.	Article	Quantity	Order Number: 1214-WG03-FD03
	Finger Seal	4	

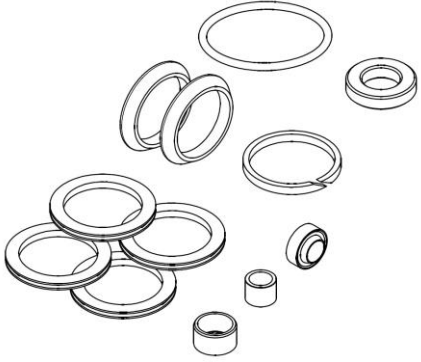
Seal Kit (complete)			
Pos.	Article:	Quantity:	Order Number: 1290-WG03-DS03
	Damping Ring	1	
	Slide Bearing	1	
	Rod Seal	1	
	Guide Band	1	
	O-ring	1	
	Piston Seal	2	
	Finger Seal	4	
	Supporting Ring	1	

Proximity Switch	
Scope of Delivery:	Order Number:
Proximity Switch (PNP) without Extension Cord	1049-WG03-PN00
Proximity Switch (PNP) with Extension Cord	1049-WG03-PN01

We only deliver to the INCOTERMS latest edition.
 All printing and clerical errors are subject to correction without liability!
 Prices and delivery times upon request.

Revision Date: 25.03.2015