

Assembly Drawing (Type: W106)

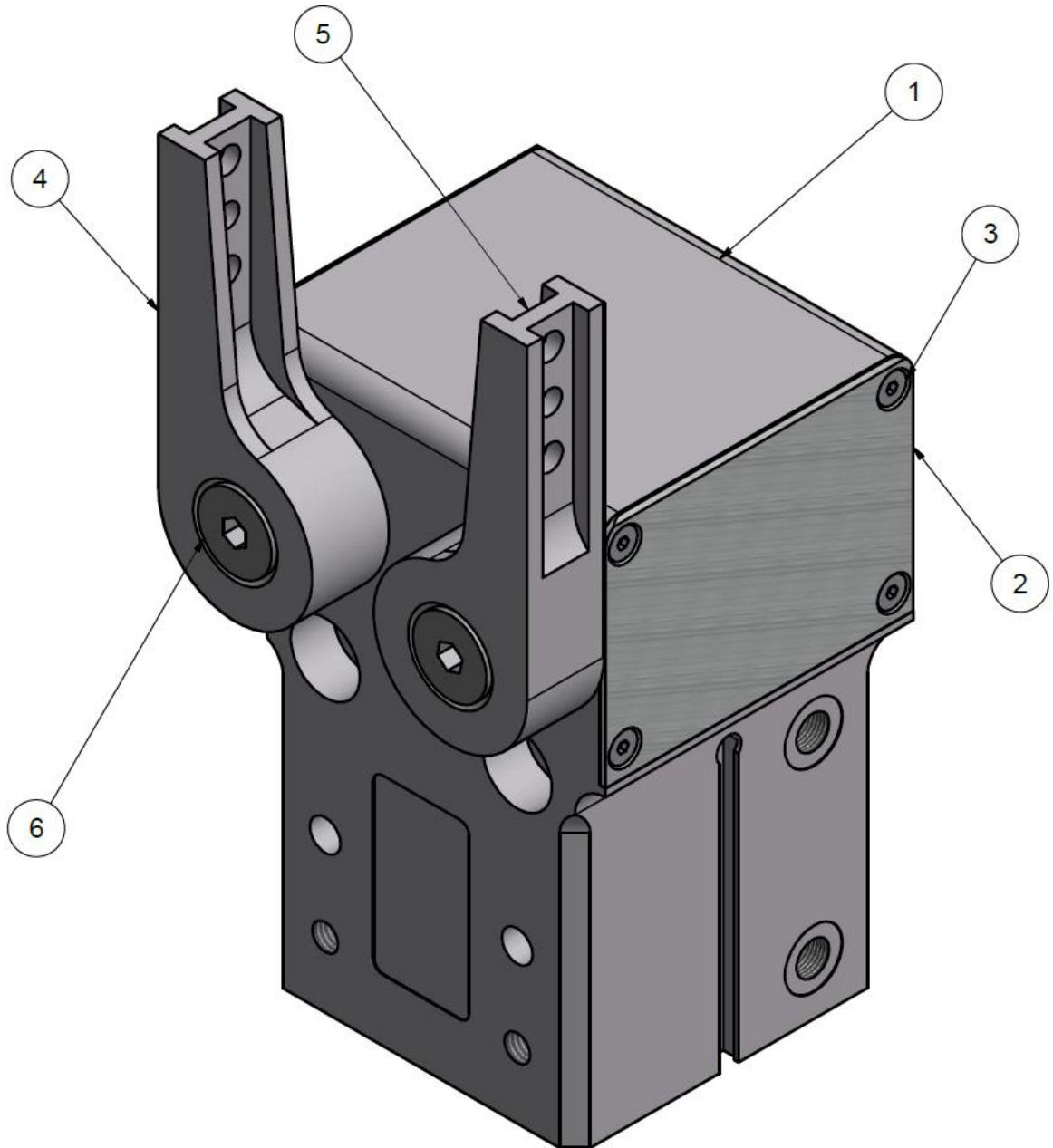

**Address:**

GMG – Gesellschaft fuer modulare  
Greifersysteme mbH  
Rodinger Weg 8H • 59494 Soest  
Germany

**Phone:**

+49 (0)2921 - 4062

**Fax:**

+49 (0)2921 - 4042

**E-mail:**

info@gmg-system.com

**Homepage:**

<http://www.gmg-system.com>

## Spare Part List for Gripper **W106**

### Gear Unit

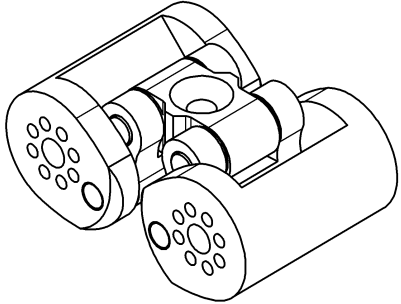
Pos.	Article	Quantity	Order Number: 1201-WG06-GE06
	Gear Unit	1	

### Piston Unit

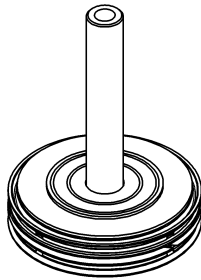
Pos.	Article	Quantity	Order Number: 1202-WG06-KE06
	Piston Unit	1	

### Finger Right (single)

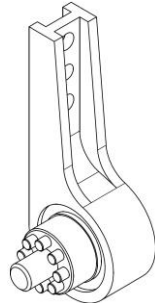
Pos.	Article	Quantity	Order Number: 1203-WG06-FR06
5	Finger Right	1	
6	Fixing Screw	1	
	Pin	8	

**Address:**

GMG – Gesellschaft fuer modulare Greifersysteme mbH  
 Rodinger Weg 8H • 59494 Soest  
 Germany

**Phone:**

+49 (0)2921 - 4062

**Fax:**

+49 (0)2921 - 4042

**E-mail:**

info@gmg-system.com

**Homepage:**

http://www.gmg-system.com

## Spare Part List for Gripper **W106**

### Finger Left (single)

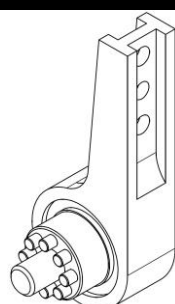
Pos.	Article	Quantity	Order Number: 1203-WG06-FL06
4	Finger Left	1	
6	Fixing Screw	1	
	Pin	8	

### Finger Pair

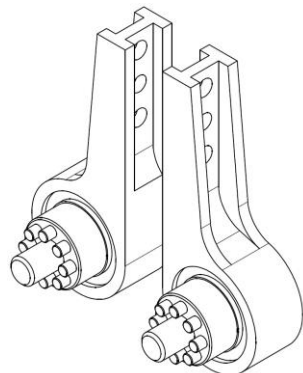
Pos.	Article	Quantity	Order Number: 1203-WG06-FP06
4	Finger Left	1	
5	Finger Right	1	
6	Fixing Screw	2	
	Pin	16	

### Finger Set

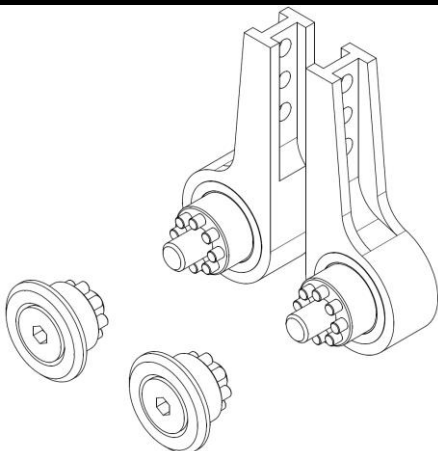
Pos.	Article	Quantity	Order Number: 1203-W106-FS06
	Counter Bearing	2	
4	Finger Left	1	
5	Finger Right	1	
6	Fixing Screw	2	
	Fixing Screw	2	
	Pin	32	
	Finger Seal	4	

**Address:**

GMG – Gesellschaft fuer modulare Greifersysteme mbH  
 Rodinger Weg 8H • 59494 Soest  
 Germany

**Phone:**

+49 (0)2921 - 4062

**Fax:**

+49 (0)2921 - 4042

**E-mail:**

info@gmg-system.com

**Homepage:**

http://www.gmg-system.com

## Spare Part List for Gripper **W106**

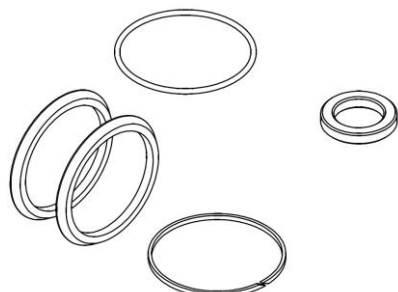
Seal Kit (small)			
Pos.	Article	Quantity	Order Number: 1204-WG06-DS06
	Damping Ring	1	
	Guide Band	1	
	O-ring	1	
	Piston Seal	2	

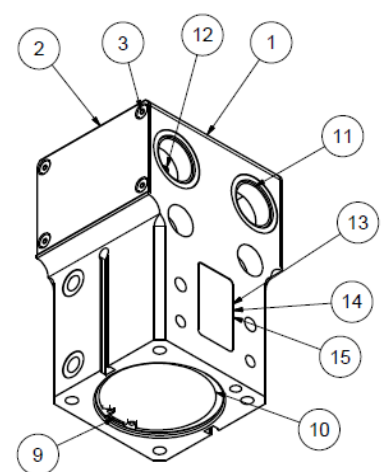
Body			
Pos.:	Article:	Quantity:	Order Number: 1205-WG06-GH06
1	Body	1	
2	Side Cover	2	
3	Fixing Screw	8	
10	Circlip	1	
9	Cylinder Cover	1	
11	Neck Bearing	4	
13	Slide Bearing	1	
14	Rod Seal	1	
15	O-ring	1	
12	Plug	1	

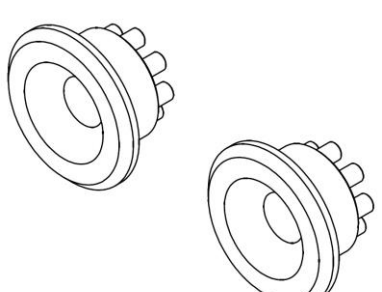
Counter Bearing			
Pos.	Article	Quantity	Order Number: 1206-WG06-WL06
	Counter Bearing	2	
	Pin	16	

**Address:**

GMG – Gesellschaft fuer modulare Greifersysteme mbH  
 Rodinger Weg 8H • 59494 Soest  
 Germany

**Phone:**

+49 (0)2921 - 4062

**Fax:**

+49 (0)2921 - 4042

**E-mail:**

info@gmg-system.com

**Homepage:**

http://www.gmg-system.com

## Spare Part List for Gripper **W106**

### Side Covers

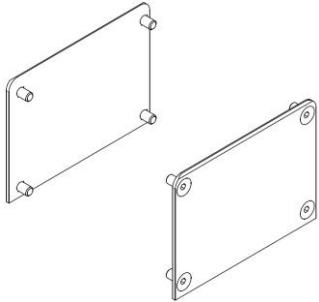
Pos.	Article	Quantity	Order Number: 1207-WG06-AB06
2	Side Cover	2	
3	Fixing Screw	8	

### Neck Bearing

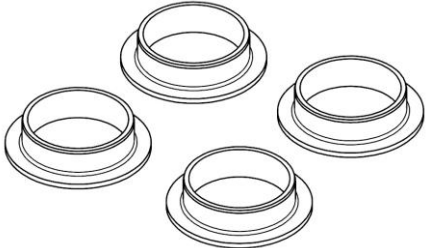
Pos.	Article	Quantity	Order Number: 1210-WG06-HL06
	Neck Bearing	4	

### Ring Magnet

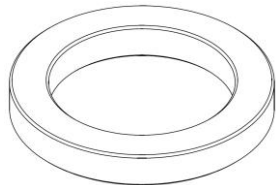
Pos.	Article	Quantity	Order Number: 1213-WG06-MR06
	Ring Magnet	1	

### Finger Seal

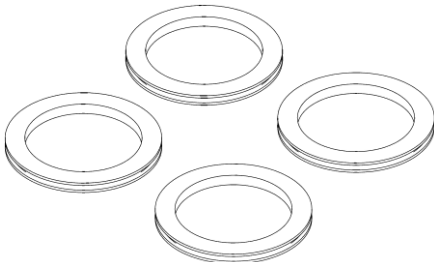
Pos.	Article	Quantity	Order Number: 1214-WG06-FD06
	Finger Seal	4	

**Address:**

GMG – Gesellschaft fuer modulare Greifersysteme mbH  
 Rodinger Weg 8H • 59494 Soest  
 Germany

**Phone:**

+49 (0)2921 - 4062

**Fax:**

+49 (0)2921 - 4042

**E-mail:**

info@gmg-system.com

**Homepage:**

http://www.gmg-system.com

## Seal Kit (complete)

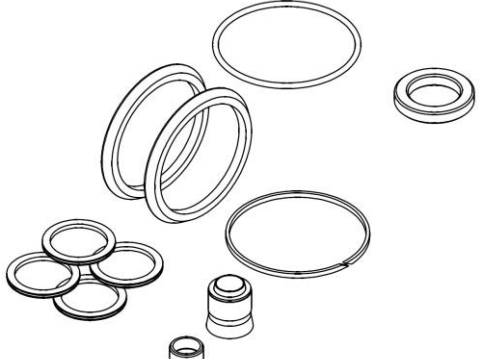
Pos.:	Article:	Quantity:	<b>Order Number: 1290-WG06-DS06</b>
	Damping Ring	1	
	Slide Bearing	1	
	Rod Seal	1	
	Guide Band	1	
	O-ring	1	
	Piston Seal	2	
	Finger Seal	4	

## Proximity Switch

Scope of Delivery:	<b>Order Number:</b>
<i>Proximity Switch (PNP) without Extension Cord</i>	<b>1049-WG06-PN00</b>
<i>Proximity Switch (PNP) with Extension Cord</i>	<b>1049-WG06-PN01</b>

**We only deliver to the INCOTERMS latest edition.  
 All printing and clerical errors are subject to correction without liability!  
 Prices and delivery times upon request.**

Revision Date: 25.03.2015