

Assembly Drawing (Type: W203)

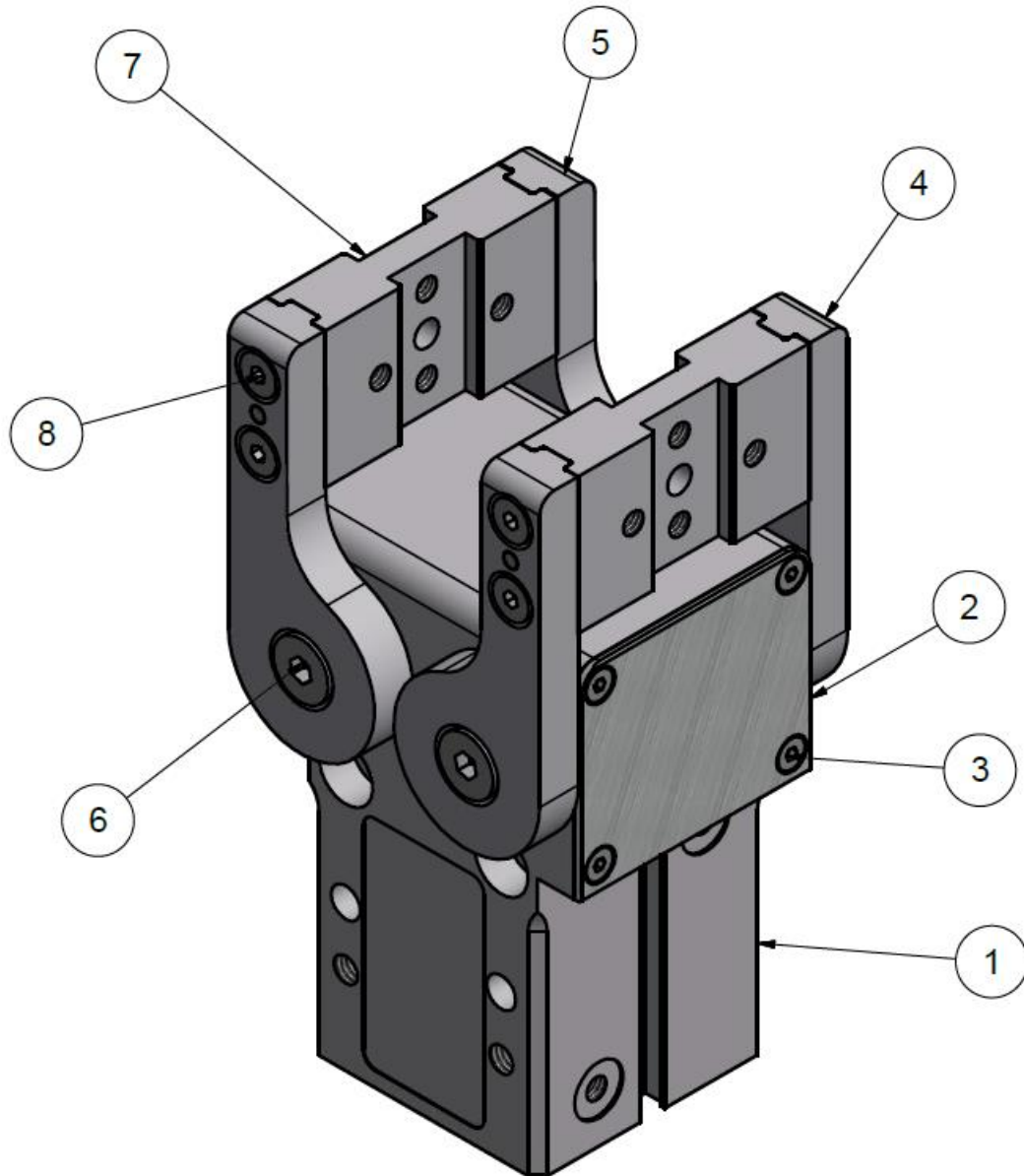

**Address:**

GMG – Gesellschaft fuer modulare  
Greifersysteme mbH  
Rodinger Weg 8H • 59494 Soest  
Germany

**Phone:**

+49 (0)2921 - 4062

**Fax:**

+49 (0)2921 - 4042

**E-mail:**

info@gmg-system.com

**Homepage:**

<http://www.gmg-system.com>

## Spare Part List for Gripper **W203**

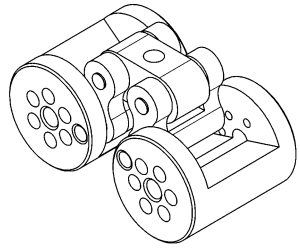
Gear Unit			
Pos.	Article	Quantity	Order Number: 1201-WG03-GE03
	Gear Unit	1	

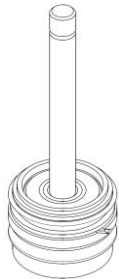
Piston Unit			
Pos.	Article	Quantity	Order Number: 1202-WG03-KE03
	Piston Unit	1	

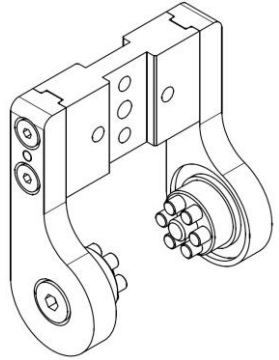
Finger (single)			
Pos.	Article	Quantity	Order Number: 1203-W203-FL03
4	Finger Left	1	
5	Finger Right	1	
7	Pad Holder	2	
6	Fixing Screw	2	
8	Fixing Screw	4	
	Finger Seal	2	

**Address:**

GMG – Gesellschaft fuer modulare Greifersysteme mbH  
 Rodinger Weg 8H • 59494 Soest  
 Germany

**Phone:**

+49 (0)2921 - 4062

**Fax:**

+49 (0)2921 - 4042

**E-mail:**

info@gmg-system.com

**Homepage:**

http://www.gmg-system.com

## Spare Part List for Gripper **W203**

<b>Finger Set</b>			
Pos.	Article	Quantity	Order Number: 1203-W203-FS03
4	Finger Right	2	
5	Finger Left	2	
7	Pad Holder	2	
7	Fixing Screw	4	
8	Fixing Screw	8	
	Finger Seal	4	

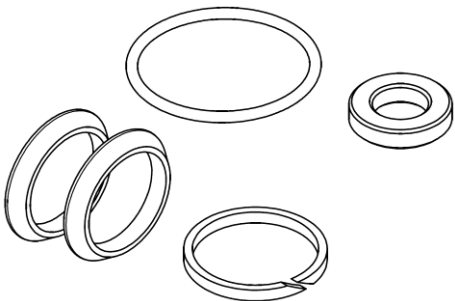
<b>Seal Kit (small)</b>			
Pos.	Article	Quantity	Order Number: 1204-WG03-DS03
	Damping Ring	1	
	Guide Band	1	
	O-ring	1	
	Piston Seal	2	

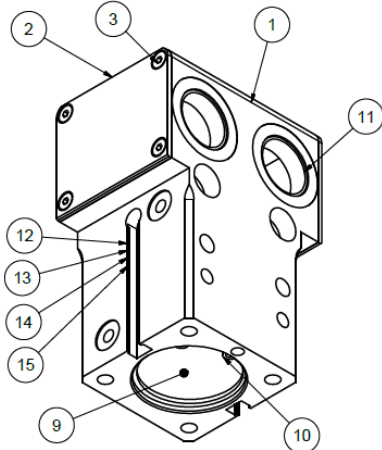
<b>Body</b>			
Pos.	Article:	Quantity:	Order Number: 1205-WG03-GH03
1	Body	1	
2	Side Cover	2	
3	Fixing Screw	8	
10	Circlip	1	
9	Cylinder Cover	1	
11	Neck Bearing	4	
12	Slide Bearing	1	
13	Rod Seal	1	
14	O-ring	1	
15	Supporting Ring	1	

**Address:**

GMG – Gesellschaft fuer modulare Greifersysteme mbH  
 Rodinger Weg 8H • 59494 Soest  
 Germany

**Phone:**

+49 (0)2921 - 4062

**Fax:**

+49 (0)2921 - 4042

**E-mail:**

info@gmg-system.com

**Homepage:**

http://www.gmg-system.com

## Spare Part List for Gripper **W203**

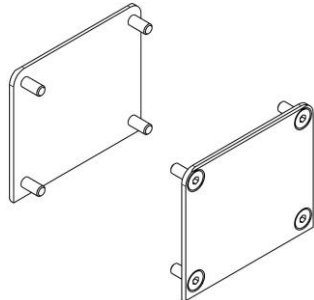
Side Covers			
Pos.	Article	Quantity	Order Number: 1207-WG03-AB03
2	Side Cover	2	
3	Fixing Screw	8	

Reduction Sleeve			
Pos.	Article	Quantity	Order Number: 1208-WG03-RH03
	Reduction Sleeve	1	
	O-ring	2	

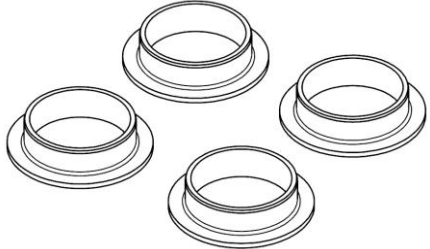
Neck Bearing			
Pos.	Article	Quantity	Order Number: 1210-WG03-HL03
11	Neck Bearing	4	

Blind Plug			
Pos.	Article	Quantity	Order Number: 1211-WG03-BS00
	Blind Plug	2	

**Address:**

GMG – Gesellschaft fuer modulare Greifersysteme mbH  
 Rodinger Weg 8H • 59494 Soest  
 Germany

**Phone:**

+49 (0)2921 - 4062

**Fax:**

+49 (0)2921 - 4042

**E-mail:**

info@gmg-system.com

**Homepage:**

http://www.gmg-system.com

## Spare Part List for Gripper **W203**

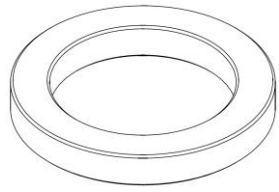
Ring Magnet			
Pos.	Article	Quantity	Order Number: 1213-WG03-MR03
	Ring Magnet	1	

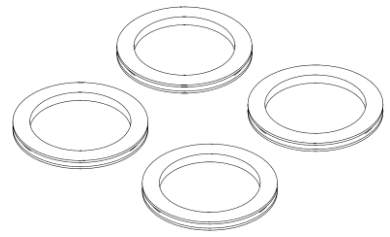
Finger Seal			
Pos.	Article	Quantity	Order Number: 1214-WG03-FD03
	Finger Seal	4	

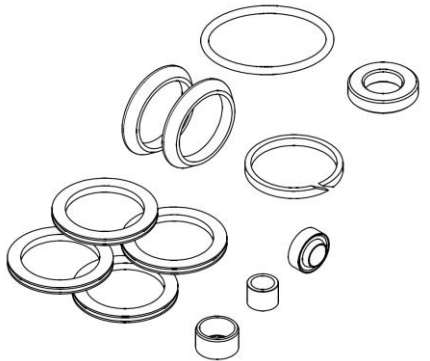
Seal Kit (complete)			
Pos.	Article:	Quantity:	Order Number: 1290-WG03-DS03
	Damping Ring	1	
	Slide Bearing	1	
	Rod Seal	1	
	Guide Band	1	
	O-ring	1	
	Piston Seal	2	
	Finger Seal	4	
	Supporting Ring	1	

Proximity Switch	
Scope of Delivery:	Order Number:
<i>Proximity Switch (PNP) without Extension Cord</i>	<b>1049-WG03-PN00</b>
<i>Proximity Switch (PNP) with Extension Cord</i>	<b>1049-WG03-PN01</b>

**We only deliver to the INCOTERMS latest edition.**  
 All printing and clerical errors are subject to correction without liability!  
 Prices and delivery times upon request.

Revision Date: 25.03.2015