

Assembly Drawing (Type: W206)

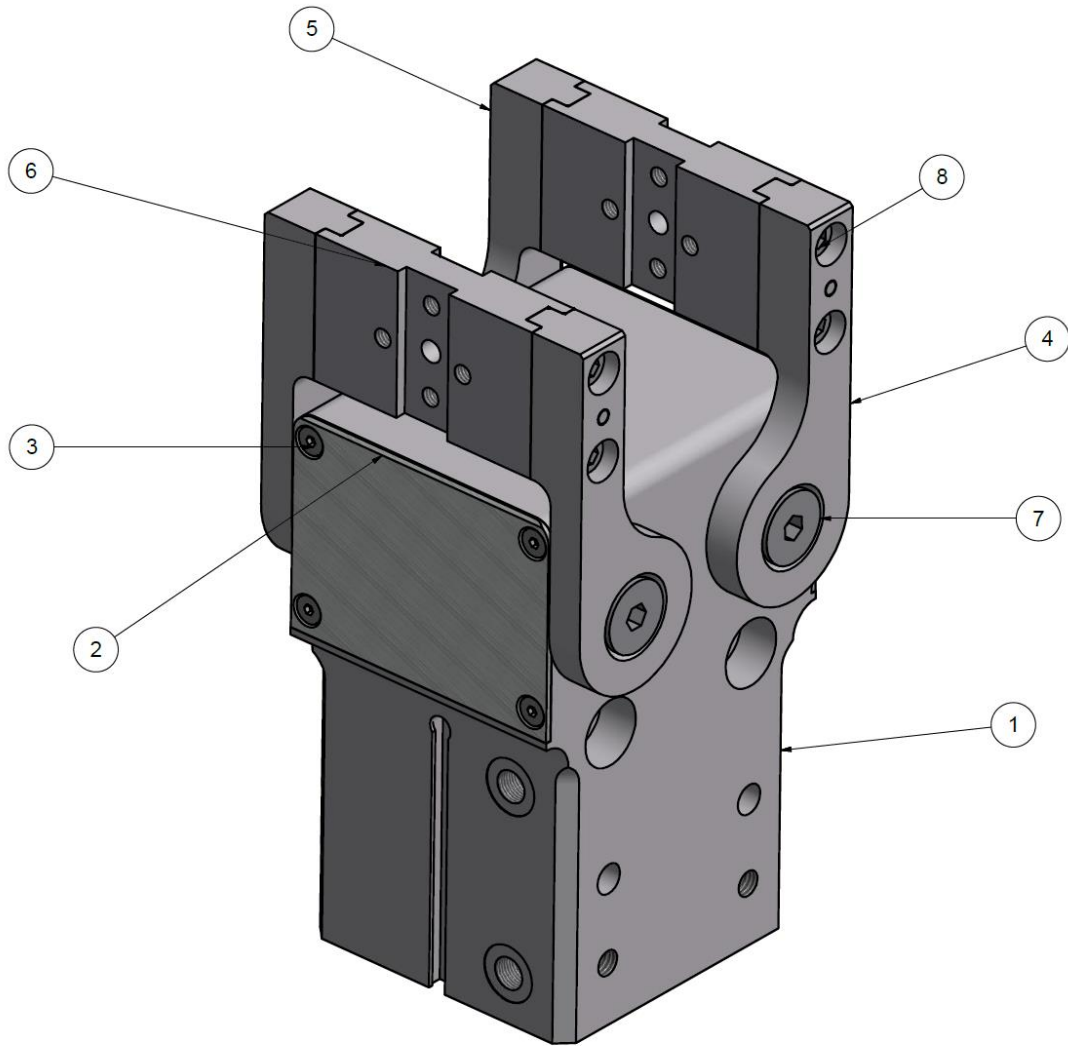

Address:

GMG – Gesellschaft fuer modulare
Greifersysteme mbH
Rodinger Weg 8H • 59494 Soest
Germany

Phone:

+49 (0)2921 - 4062

Fax:

+49 (0)2921 - 4042

E-mail:

info@gmg-system.com

Homepage:

<http://www.gmg-system.com>

Spare Part List for Gripper **W206**

Gear Unit

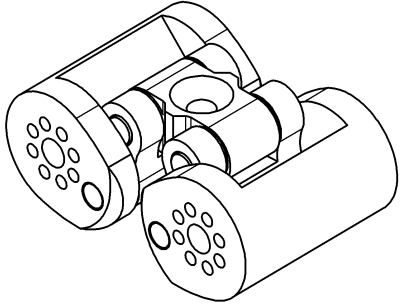
Pos.	Article	Quantity	Order Number: 1201-WG06-GE06
	Gear Unit	1	

Piston Unit

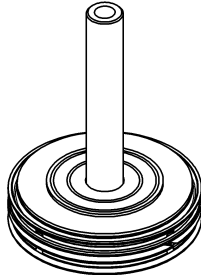
Pos.	Article	Quantity	Order Number: 1202-WG06-KE06
	Piston Unit	1	

Finger (single)

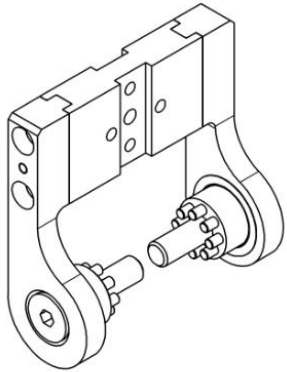
Pos.	Article	Quantity	Order Number: 1203-W206-FL06
4	Finger Left	1	
5	Finger Right	1	
6	Pad Holder	2	
7	Fixing Screw	2	
8	Fixing Screw	4	
	Finger Seal	2	

Address:

GMG – Gesellschaft fuer modulare Greifersysteme mbH
 Rodinger Weg 8H • 59494 Soest
 Germany

Phone:

+49 (0)2921 - 4062

Fax:

+49 (0)2921 - 4042

E-mail:

info@gmg-system.com

Homepage:

http://www.gmg-system.com

Finger Set

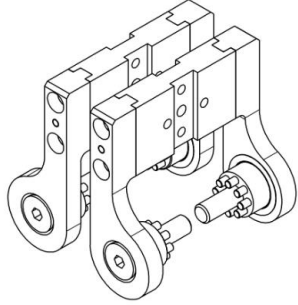
Pos.	Article	Quantity	Order Number: 1203-W206-FS06
4	Finger Right	2	
5	Finger Left	2	
6	Pad Holder	2	
7	Fixing Screw	4	
8	Fixing Screw	8	
	Finger Seal	4	

Seal Kit (small)

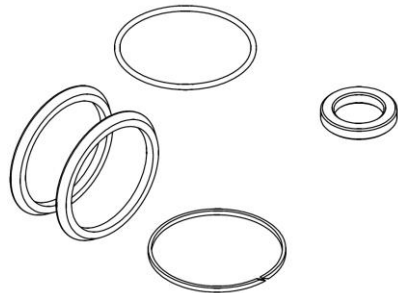
Pos.	Article	Quantity	Order Number: 1204-WG06-DS06
	Damping Ring	1	
	Guide Band	1	
	O-ring	1	
	Piston Seal	2	

Body

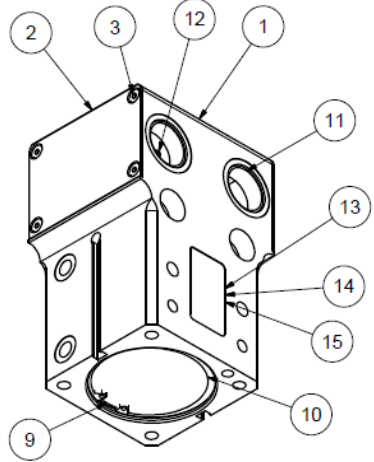
Pos.	Article:	Quantity:	Order Number: 1205-WG06-GH06
1	Body	1	
2	Side Cover	2	
3	Fixing Screw	8	
10	Circlip	1	
9	Cylinder Cover	1	
11	Neck Bearing	4	
13	Slide Bearing	1	
14	Rod Seal	1	
15	O-ring	1	
12	Plug	1	

Address:

GMG – Gesellschaft fuer modulare Greifersysteme mbH
 Rodinger Weg 8H • 59494 Soest
 Germany

Phone:

+49 (0)2921 - 4062

Fax:

+49 (0)2921 - 4042

E-mail:

info@gmg-system.com

Homepage:

http://www.gmg-system.com

Spare Part List for Gripper **W206**

Side Covers

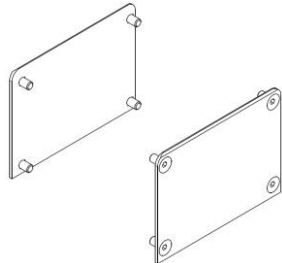
Pos.	Article	Quantity	Order Number: 1207-WG06-AB06
2	Side Cover	2	
3	Fixing Screw	8	

Neck Bearing

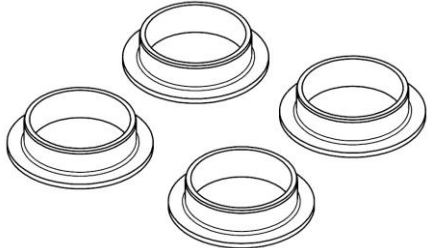
Pos.	Article	Quantity	Order Number: 1210-WG06-HL06
11	Neck Bearing	4	

Ring Magnet

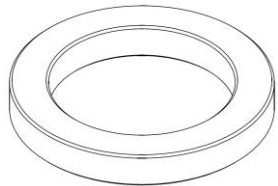
Pos.	Article	Quantity	Order Number: 1213-WG06-MR06
	Ring Magnet	1	

Finger Seal

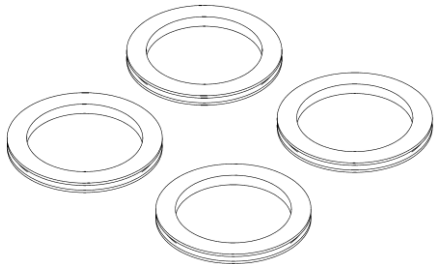
Pos.	Article	Quantity	Order Number: 1214-WG06-FD06
	Finger Seal	4	

Address:

GMG – Gesellschaft fuer modulare Greifersysteme mbH
 Rodinger Weg 8H • 59494 Soest
 Germany

Phone:

+49 (0)2921 - 4062

Fax:

+49 (0)2921 - 4042

E-mail:

info@gmg-system.com

Homepage:

http://www.gmg-system.com



Spare Part List for Gripper **W206**

Seal Kit (complete)

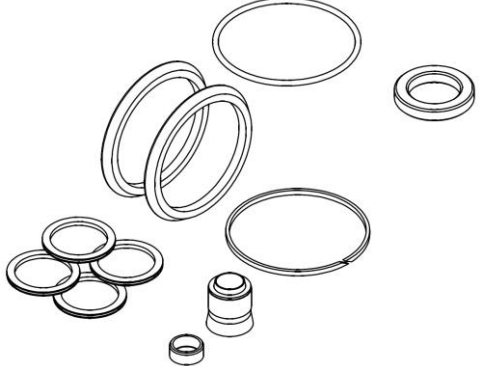
Pos.	Article:	Quantity:	Order Number: 1290-WG06-DS06
	Damping Ring	1	
	Slide Bearing	1	
	Rod Seal	1	
	Guide Band	1	
	O-ring	1	
	Piston Seal	2	
	Finger Seal	4	

Proximity Switch

Scope of Delivery:	Order Number:
<i>Proximity Switch (PNP) without Extension Cord</i>	1049-WG06-PN00
<i>Proximity Switch (PNP) with Extension Cord</i>	1049-WG06-PN01

We only deliver to the INCOTERMS latest edition.
 All printing and clerical errors are subject to correction without liability!
 Prices and delivery times upon request.

Revision Date: 25.03.2015

Address:

GMG – Gesellschaft fuer modulare
 Greifersysteme mbH
 Rodinger Weg 8H • 59494 Soest
 Germany

Phone:

+49 (0)2921 - 4062

Fax:

+49 (0)2921 - 4042

E-mail:

info@gmg-system.com

Homepage:

http://www.gmg-system.com